



3D Disto Software
for Windows®

Leica 3D Disto Tutorial



«Projector» in stair case

- when it has to be **right**

Leica
Geosystems

Projector in stair case

Workflow description:

Measurement → Stair Design → Projection of fixing points

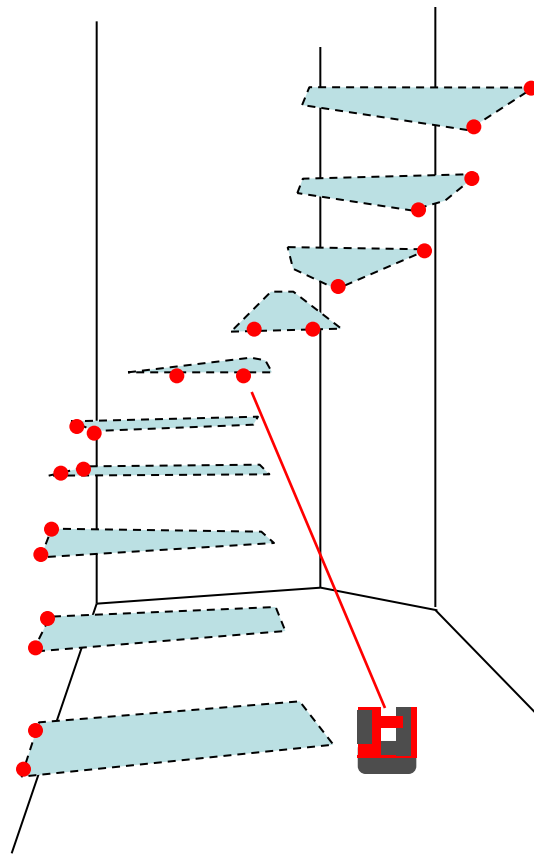

- when it has to be **right**

Projector in stair case

Preparing the measurement

1

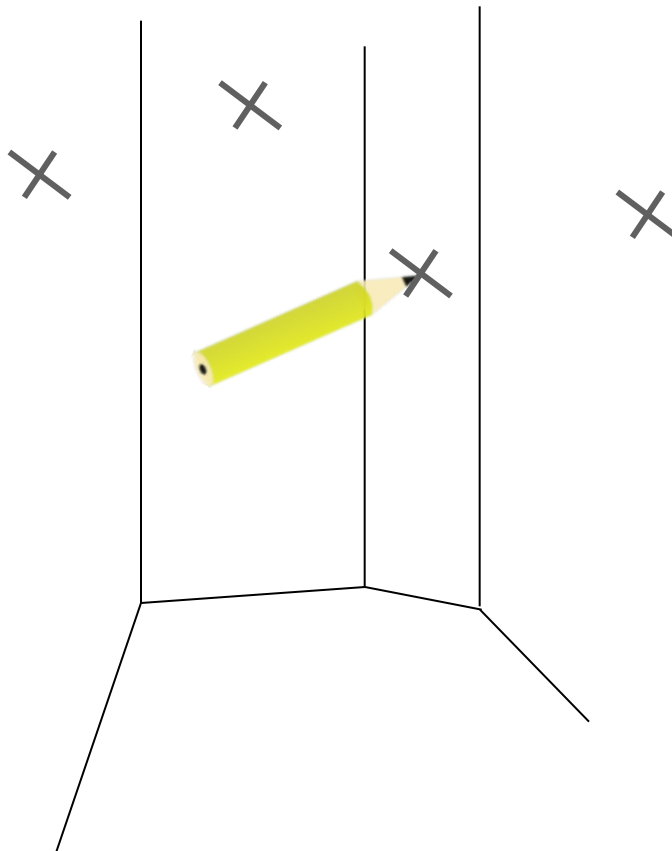

- mark 1 point on each wall of the stair case

- when it has to be **right**

Projector in stair case

Measurement of existing geometry

2

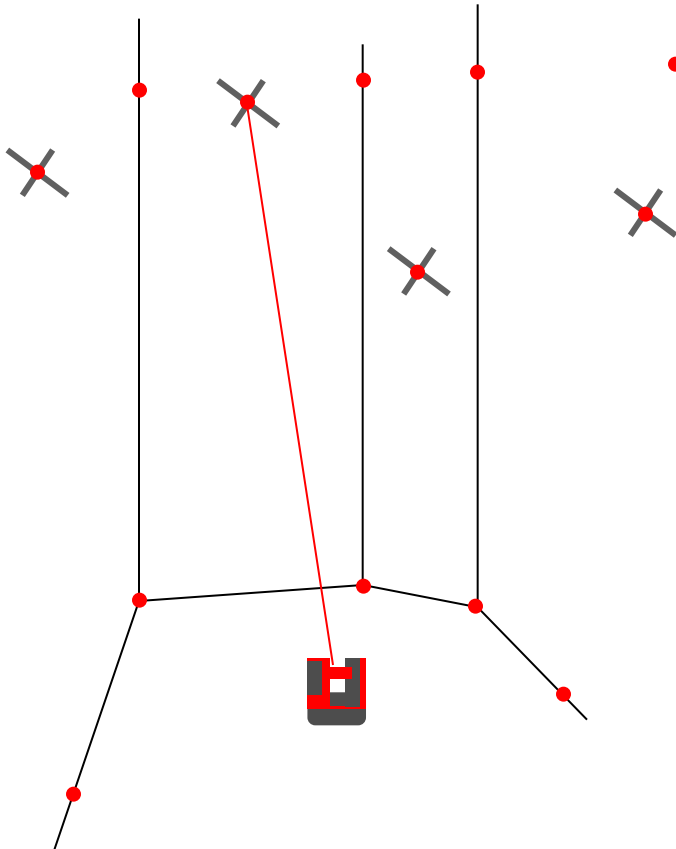

- measure all corners, walls and details of interest
- measure all your marks

- when it has to be **right**

Projector in stair case

Export to CAD

3

- Save the data
- Start „File Manager“, select file, press „export“ key
- Import to your CAD system.



- when it has to be **right**

Projector in stair case

CAD works

4

- Design the stair and the fixing points in CAD

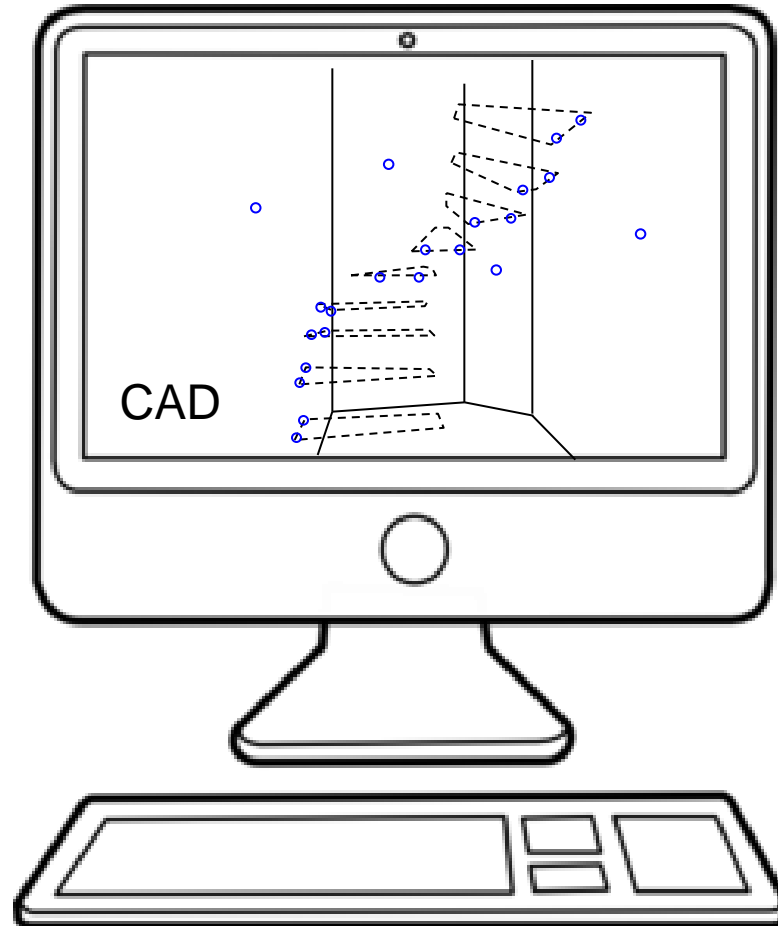

- when it has to be **right**

Projector in stair case

Export design data

5

- Export 1 file for each wall. The marked point of each wall must be in the file, too. Accepted file format is DXF or CSV
- Copy the files to the „import“ folder on your desktop

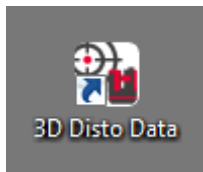
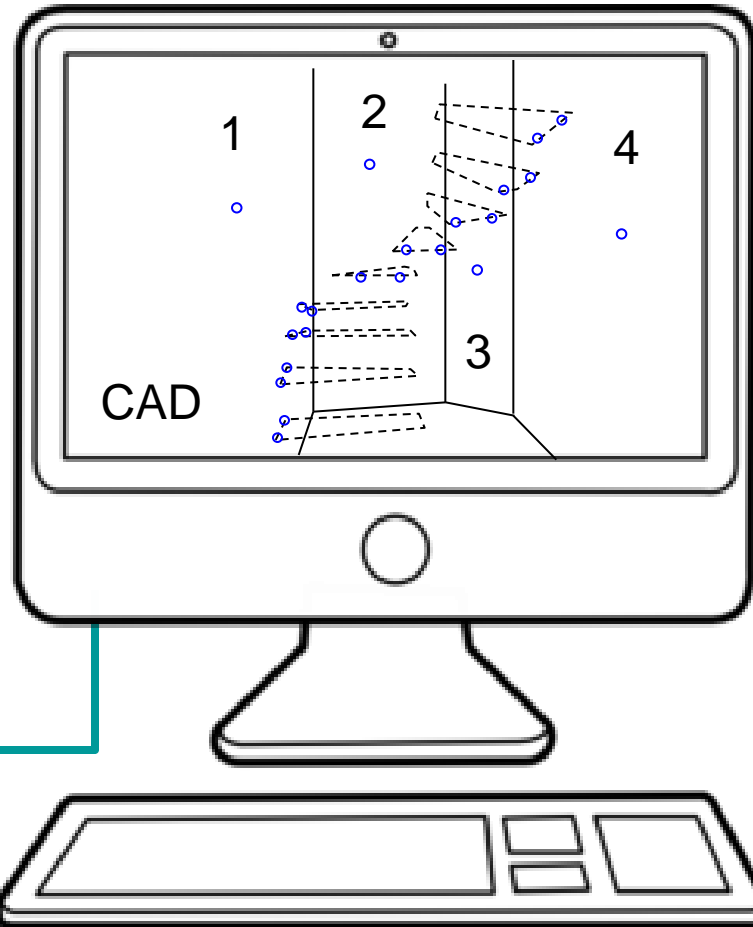

- when it has to be **right**

Projector in stair case

Choose working area

6

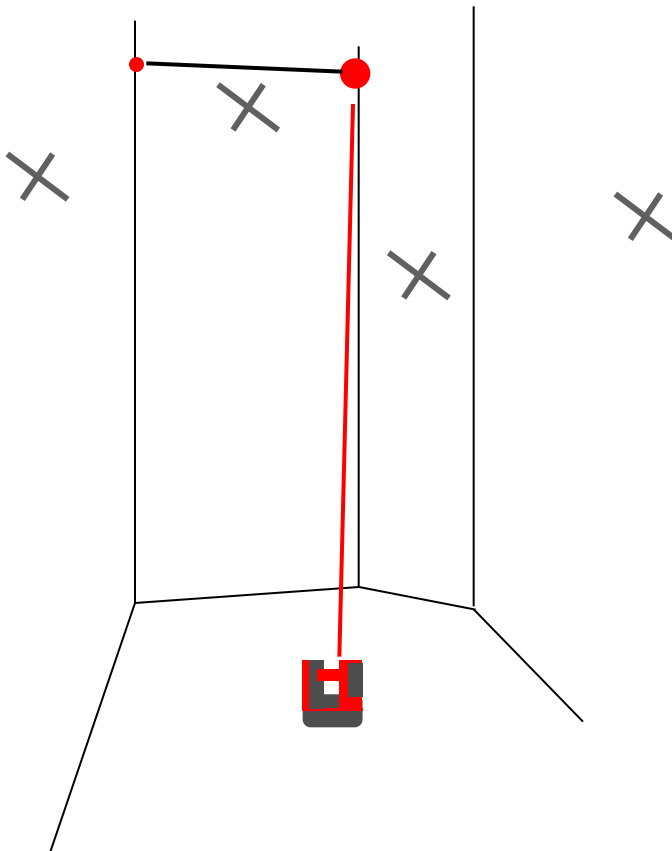

- Start Projector application

- select option ,vertical'

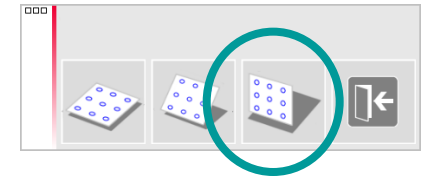

- assistant prompts how to proceed

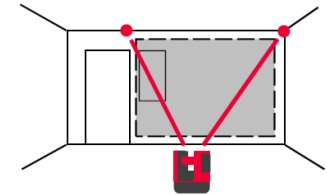

- measure 2 points on the wall

- press checkmark key



- when it has to be **right**

Projector in stair case

Measure the mark

7

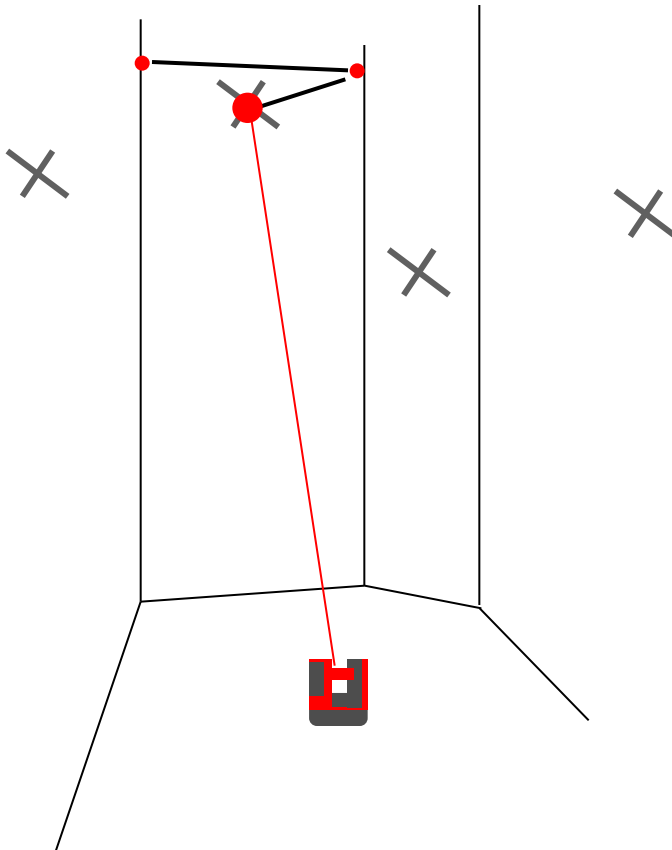

- assistant prompts how to proceed

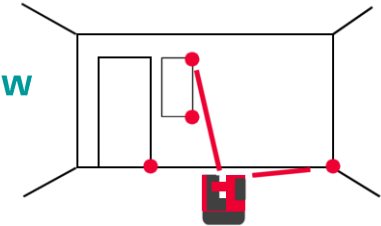

- now measure the mark

- Press checkmark



- when it has to be right

Projector in stair case

Import design data

8

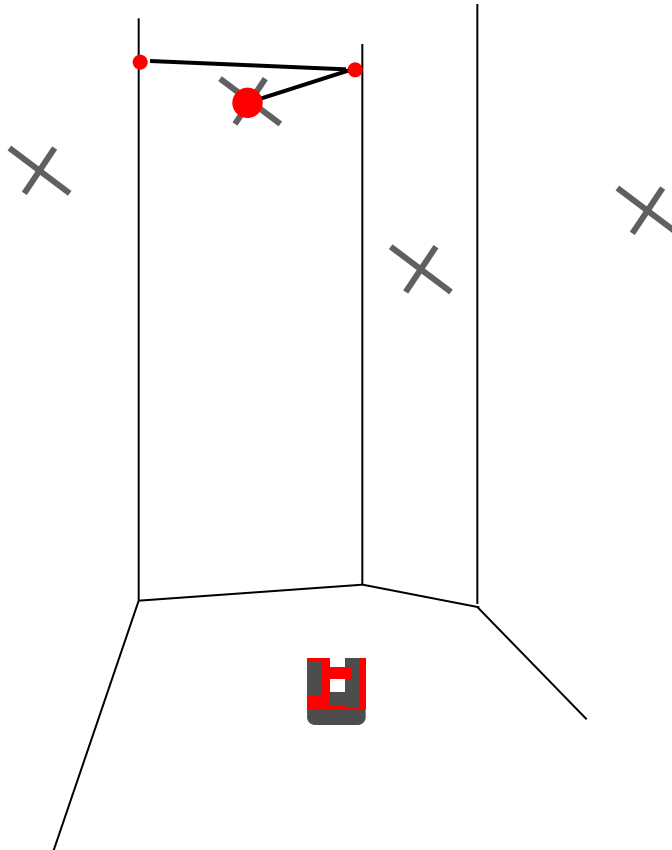

- Choose option **IMPORT**
- Select the design file that corresponds to the wall (use viewer to check)
- Press **checkmark**

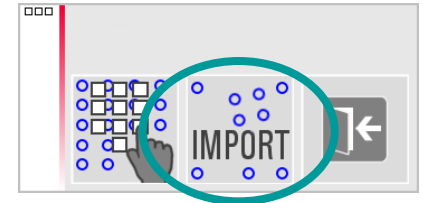

- when it has to be **right**

Projector in stair case

Adjust design points on the screen (1)

9

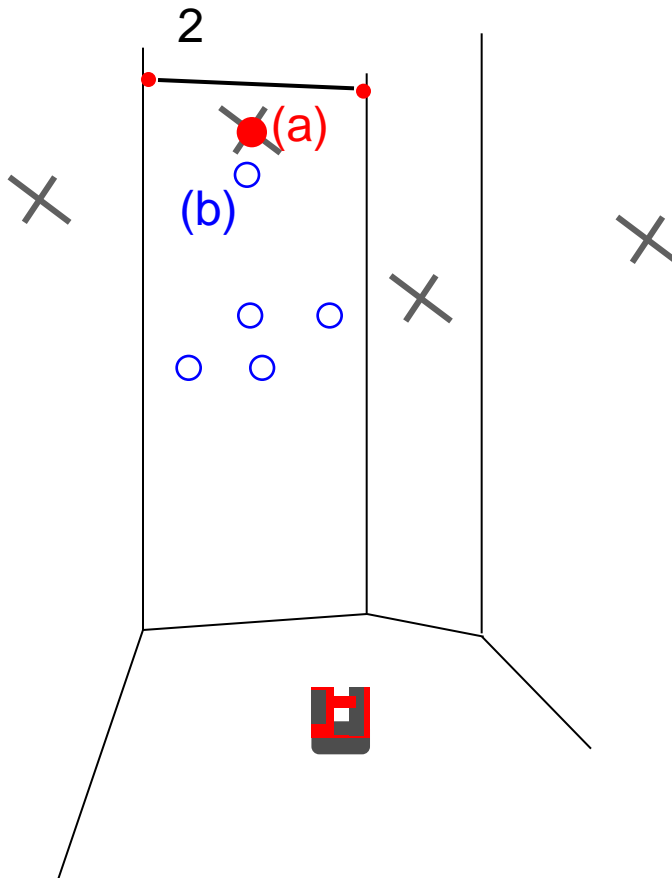

- imported data appears blue on the screen and needs to be moved to right position now:

ON SCREEN:

- tip on red point of the measured mark (a)
- tip on the corresponding blue design point (b)

(both points must be highlighted)

- when it has to be **right**

Projector in stair case

Adjust design points on the screen (2)

9

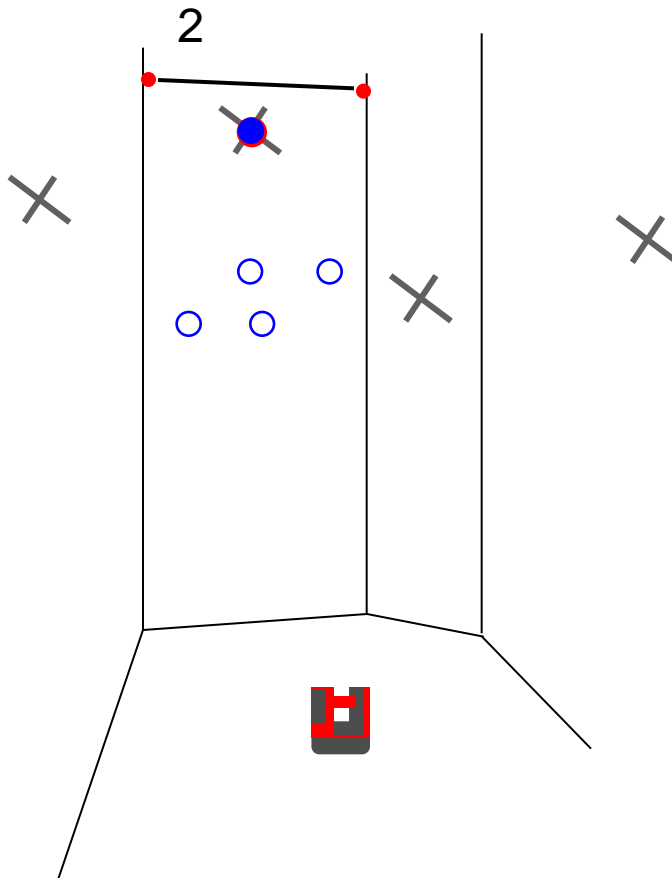

ON SCREEN:

- press COVER key
- design points move to the correct position
- press checkmark



- when it has to be **right**

Projector in stair case

Projection of design points

10

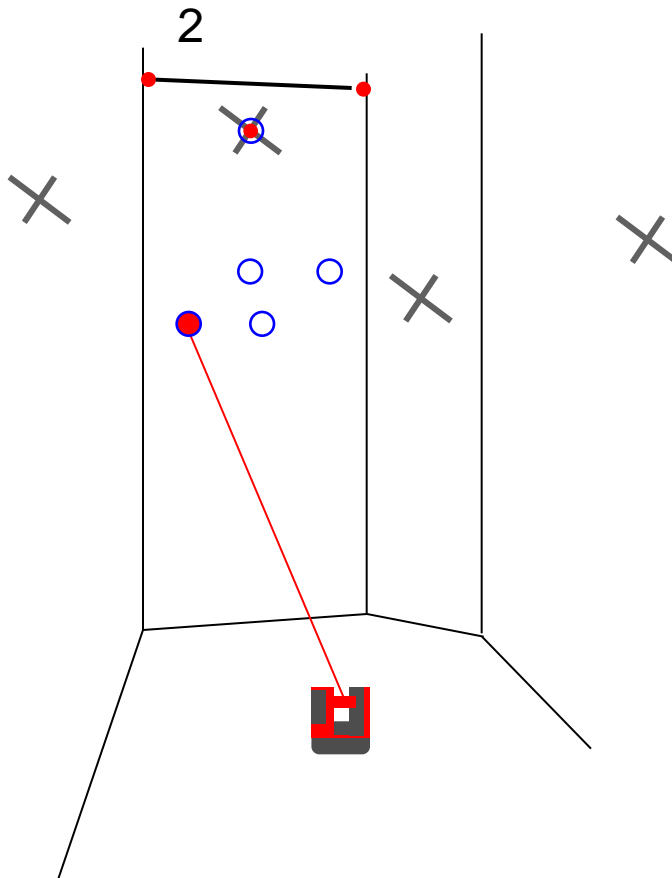

ON SCREEN:

- tip/select a blue design point or use arrow keys for selection
- press DIST → laser beam indicates position precisely. Point is found if the laser blinks.



- when it has to be right

Projector in stair case

Projection of design points

11

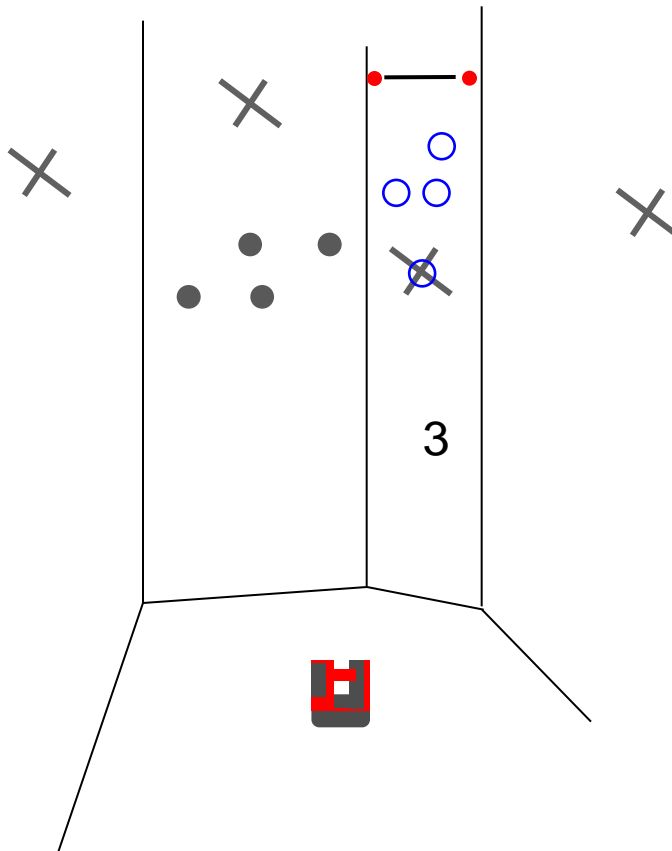

Restart PROJECTOR application and repeat workflow on the other walls

- when it has to be **right**

Projector in stair case

Additional advices:

- Accuracy on uneven surfaces
- How to increase security and accuracy
- Workflow on curved or polygonal surfaces

Projector in stair case

Accuracy on uneven surfaces

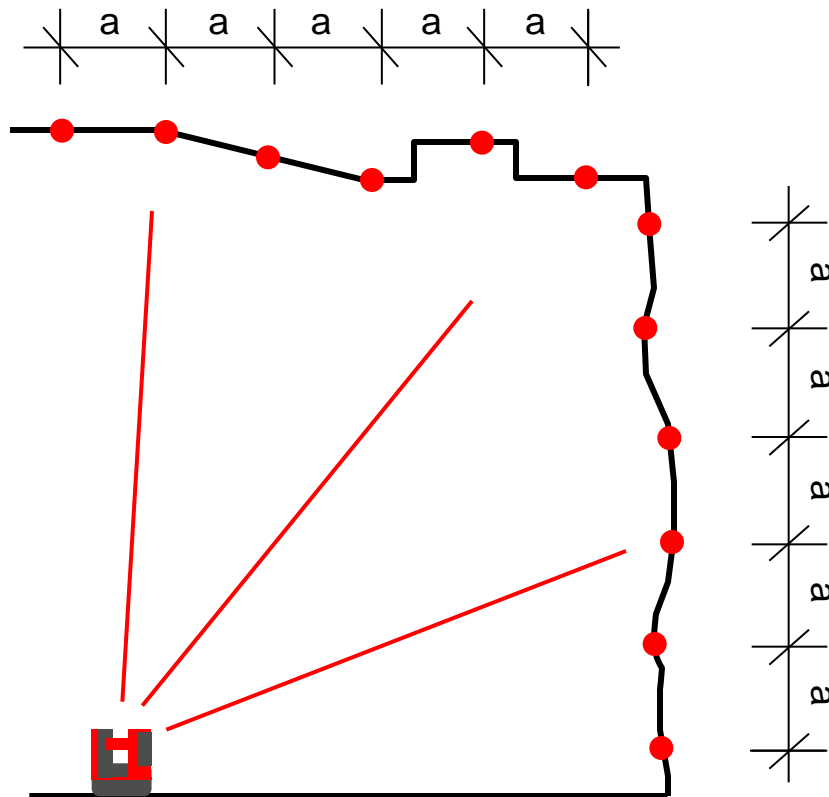

Uneven surfaces are no problem.
Projector indicates all points precisely and error-free!

- when it has to be **right**

Projector in stair case

Increase security and accuracy with more marked points

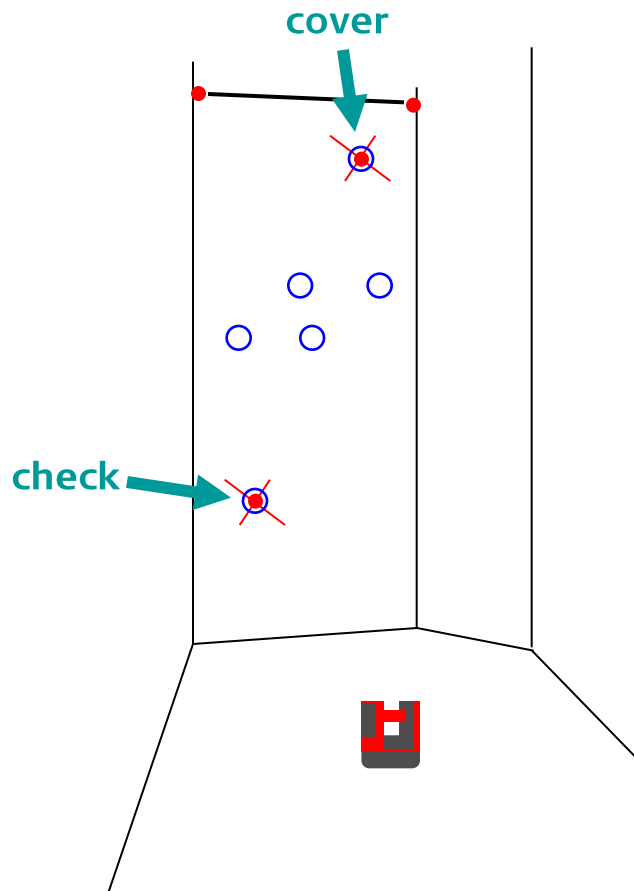

If you mark two points on each wall you have a control check for the correct position of the design points:

- cover measured mark and design point as described before
- then select the second pair of points and check the indicated distance → it should be „0“
- continue



- when it has to be **right**

Projector in stair case

Workflow on curved surfaces

1

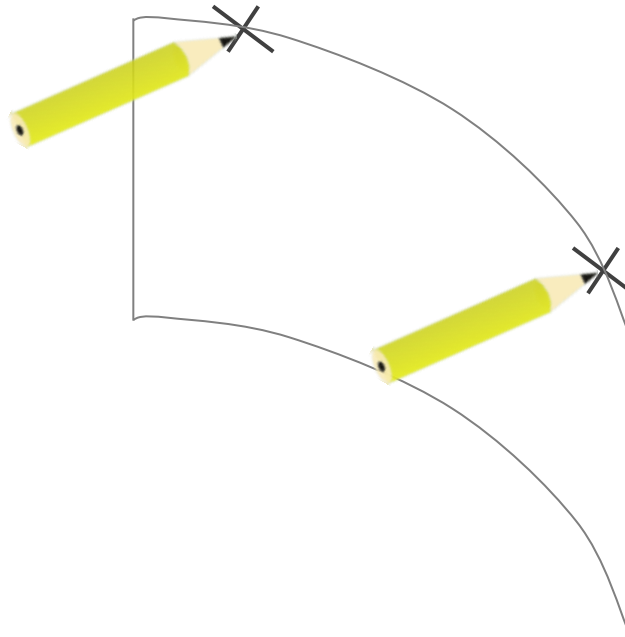

Mark 2 points
approximately on
the same level on
the working area

- when it has to be **right**

Projector in stair case

Workflow on curved surfaces

2

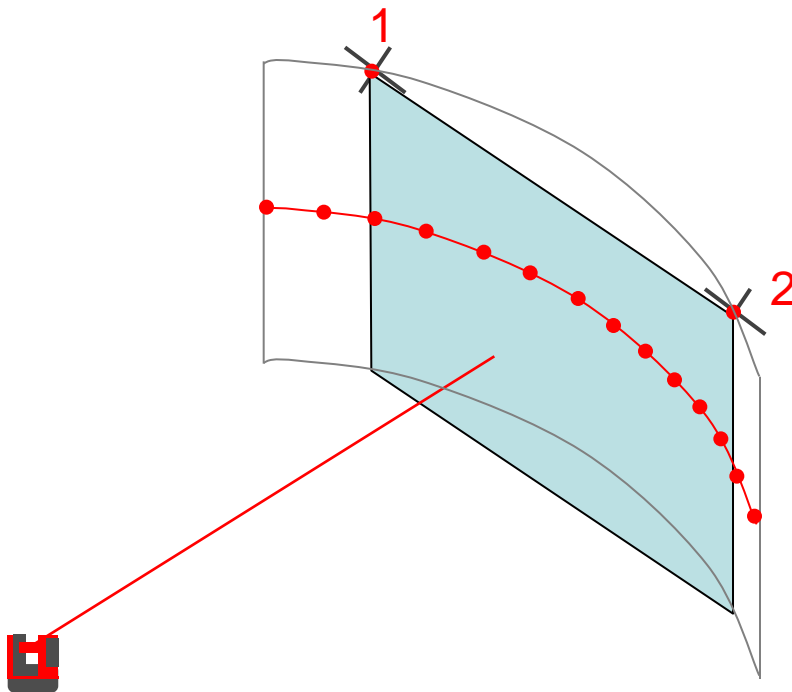

- Measure all you need for the stairs, scan, etc.....
- measure both marks
- Save and export the data

- when it has to be **right**

Projector in stair case

Workflow on curved surfaces

4

- Design the stair and the fixing points in CAD

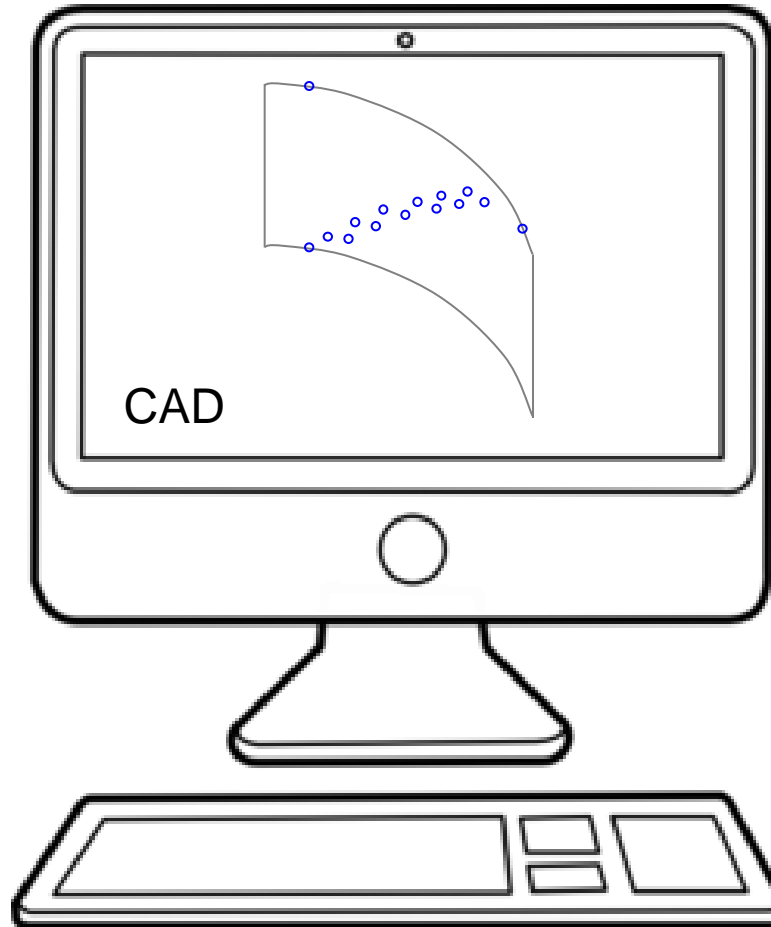

- when it has to be **right**

Projector in stair case

Workflow on curved surfaces

4

Transform all points onto a vertical plane through both marks

That distorts the geometry but points will be at correct position if projected on the bulge.

Export data to DXF file (drawing) or CSV file (chart).

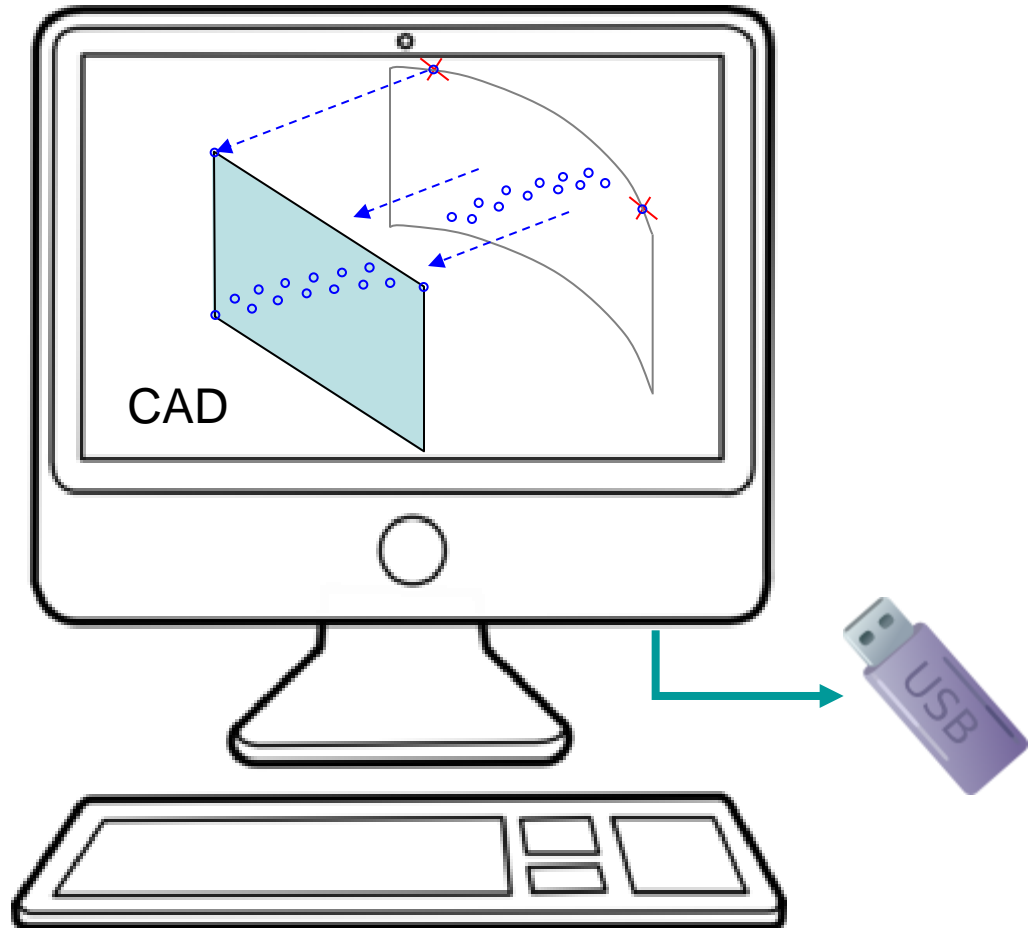

- when it has to be **right**

Projector in stair case

Workflow on curved surfaces

5

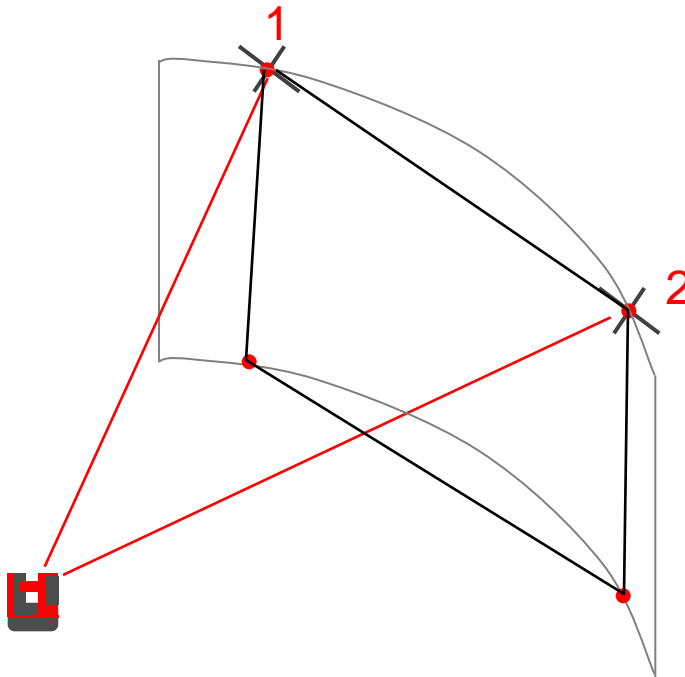

- Copy the data to the «import» folder on your desktop
- Start Projector ,vertical'
- Measure the existing marks first, further points if necessary
- Import the design file

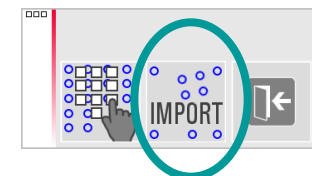
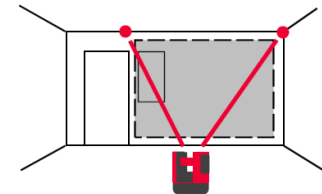
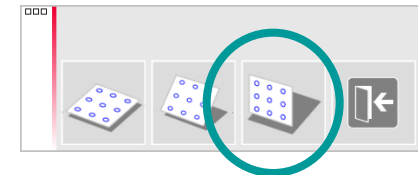
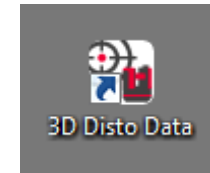

- when it has to be **right**

Projector in stair case

Workflow on curved surfaces

6

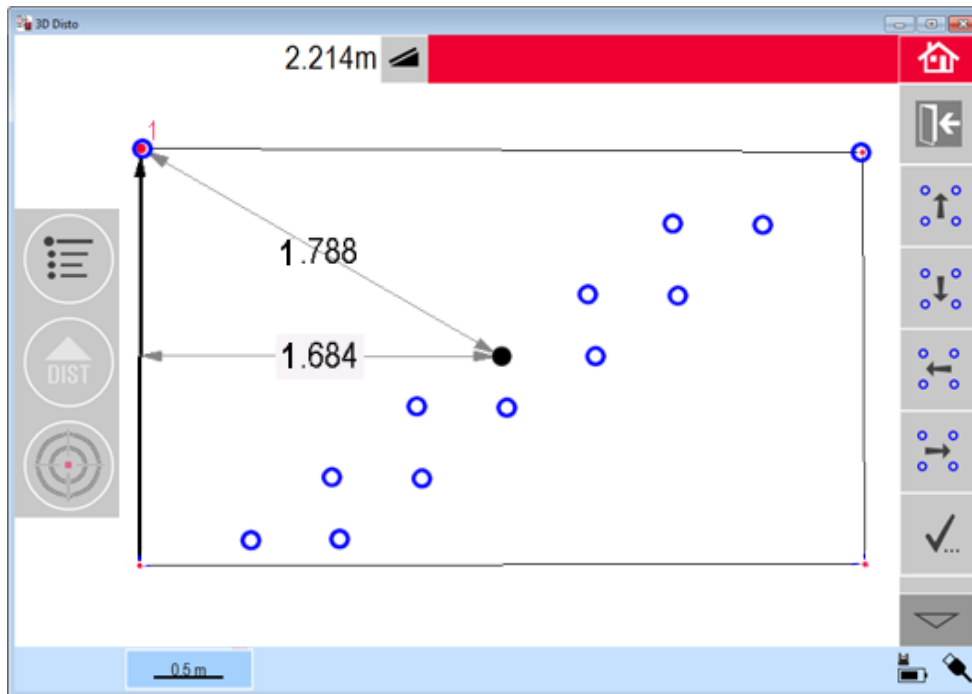

- Cover the corner points and measured points (use COVER key)



- Check correct position (click on points and lines → dimensions appear)

- Press checkmark if ok



- when it has to be **right**

Projector in stair case

Workflow on curved surfaces

7

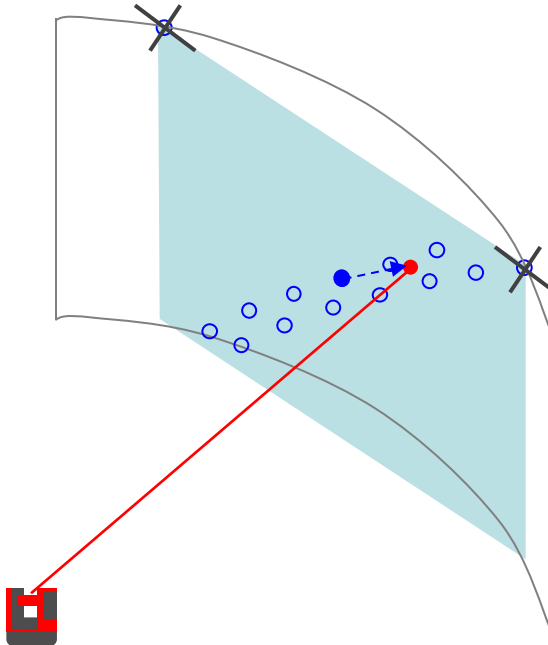

Set out like usual.
Points are projected
to the correct
position on the
curved surface.

- when it has to be **right**

Projector in stair case

Workflow on curved surfaces

8

After each projection the distance to the plane is indicated.

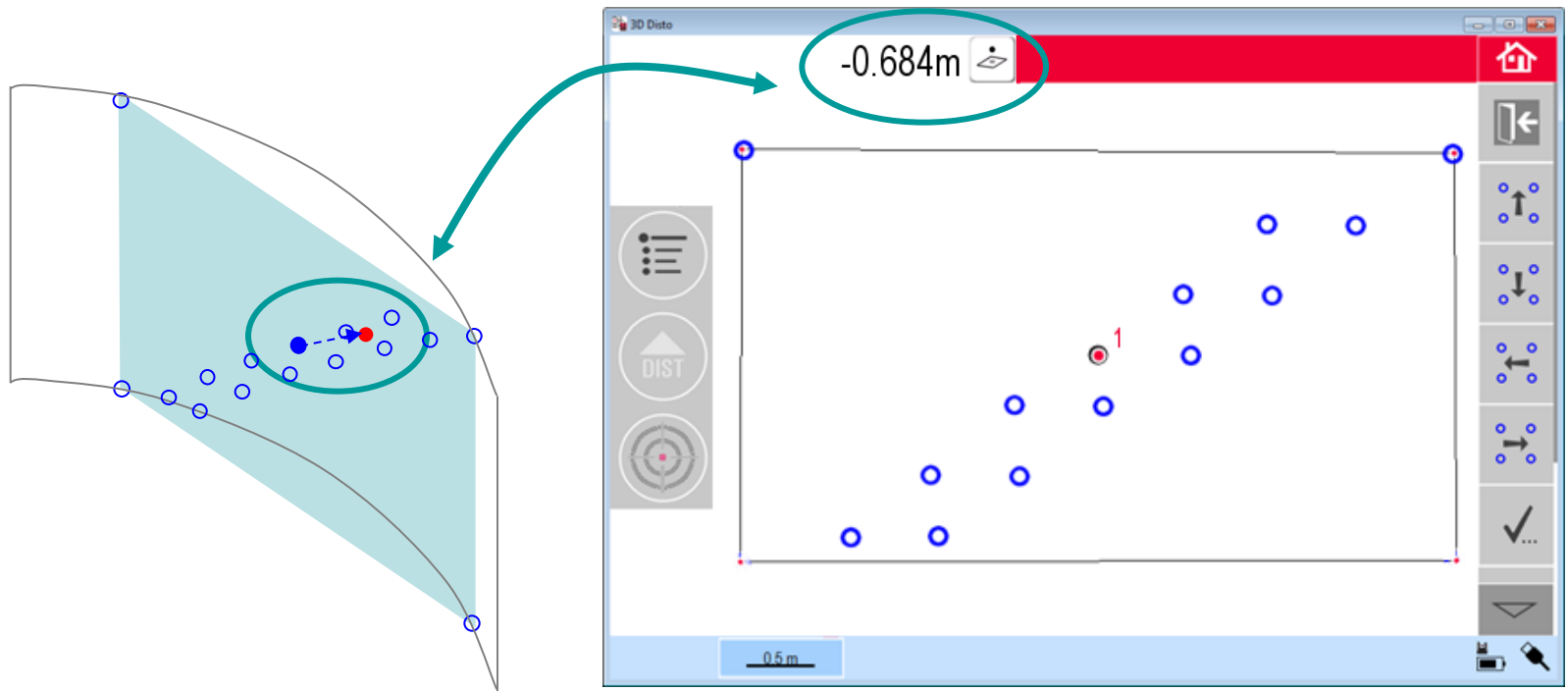

- when it has to be **right**

Leica 3D Disto

Registration at myWorld



Register your 3D Disto on myWorld for:

- warranty extension
- license keys
- more tutorials
- free software updates
- support
- manuals

myworld
@Leica Geosystems

- when it has to be right **Leica**
Geosystems

Anmeldung

E-Mail

Passwort

Anmelden

› Registrieren
› Passwort vergessen
› Support

Willkommen bei myWorld@Leica Geosystems

myWorld@Leica Geosystems bietet den Kunden und Partnern von Leica Geosystems ein breites Angebot an Services, Informationen und Schulungsunterlagen. Mit myWorld können Sie direkt auf alle wichtigen Services zugreifen - rund um die Uhr und jeden Tag! Mit myWorld stellen Sie sicher, dass Sie laufend die neuesten Informationen von Leica Geosystems bekommen und Ihre Instrumente und Software auf dem neuesten Stand sind. Und damit erhöhen Sie Ihre Produktivität.

Die Welt von Leica Geosystems ist nur einen Mausklick entfernt - treten Sie ein: myWorld@Leica Geosystems!

www.disto.com